

## Soakable/Autoclavable Endoscope Optical Coupler



Endoscope optical Coupler is a CCD HD Lens, connected between front end lens (rigid/flexible) and camera head of the endoscope, to change the optical signal from said front end lens into image that the CCD sensor of said camera head can recognize and process.

LenOpTec have engaged in developing the good quality products for many years and from 2009, the full series of soakable/Autoclavable couplers have come out and praised by our old partners. The main features are shown as below:

1. Good waterproof and air-tightness design to reach the soakable and Autoclavable functions for easy cleaning and sterilization.
2. Special treatment inside of the coupler to reduce the air, which makes it not easy to be fogged.
3. High optical definition designed for better use with 1280\*1024pixels CCD sensor. More than 200pixels/mm at the fringe of the 1/2" field.
4. Improved the noise light elimination by special design. A nice center of the optical system has been improved to ensure the good image quality.
5. Standard C or CS mount design, compatible with many different camera heads from WOLF, STORZ and PANASONIC etc.
6. Special treatment for the mechanical structures to bring a good handle and abrasion resistance.

### Different focal length couplers/adapters for choice



Model Number	LEOA14	LEOA18	LEOA20
Focal Length (mm)	14	18	20
CCD Resolution (Pixels)	1280×1024	1280×1024	1280×1024
Format	1/2"	1/2"	1/2"
Mount	CS	C/CS	C/CS
Dimension (mm)	φ54×L36	φ54×L36	φ54×L36



Model Number	LEOA22	LEOA25	LEOA28
Focal Length (mm)	22	25	28
CCD Resolution (Pixels)	1280×1024	1280×1024	1280×1024
Format	1/2"	1/2"	1/2"
Mount	C/CS	C/CS	C/CS
Dimension (mm)	φ54×L36	φ54×L36	φ54×L36



# VisionScope Technologies



Model Number	LEOA32	LEOA35
Focal Length (mm)	32	35
CCD Resolution (Pixels)	1280×1024	1280×1024
Format	1/2"	1/2"
Mount	C/CS	C/CS
Dimension (mm)	φ54×L36	φ54×L36

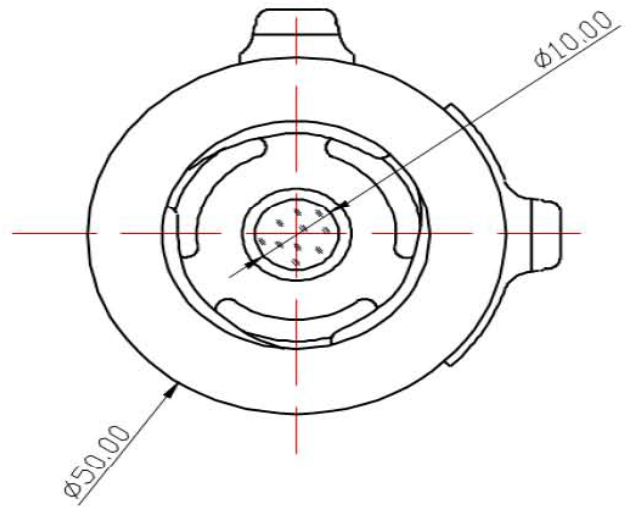
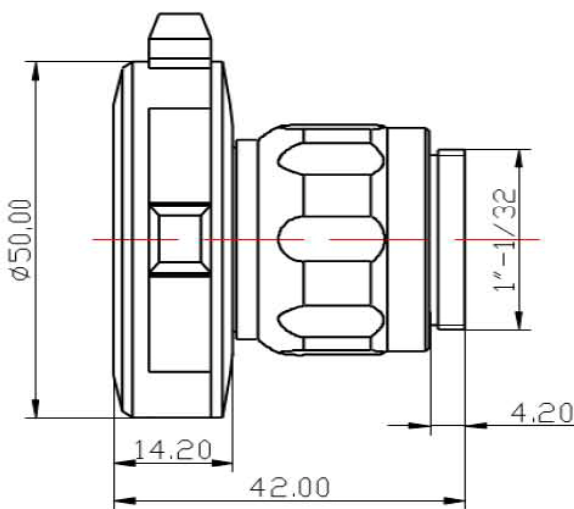

LenOpTec®



[www.vision scopetechnologies.co.uk](http://www.vision scopetechnologies.co.uk)

VisionScope Technologies, 3 Pendrick Close, Coton, Cambridge, CB23 7GZ, UK.

Tel: 01223 655740. Fax: 01223 281107  
visionscope@btinternet.com